

# Guang Zhou Mankun Electronic Co.,Ltd 廣州滿坤電子有限公司

## WELCOME

2018 Outstanding Patent Attorney in Guangzhou

In line with "honesty, customer first, care service"  
The spirit of enterprise with "high quality, excellent price,  
high efficiency,"Punctuality as a business policy.

本著“誠信、顧客至上、用心服務”  
的企業精神，以“高質、價優、高效、  
准時”為經營方針。



# 畫冊目錄

# CATALOG

2018 Outstanding Patent Attorney in Guangzhou



滿足顧客真正的需要，盡力為國內外客戶提供滿意的產品。讓滿坤成為您信賴的伙伴。

To meet the real needs of customers, to provide domestic and foreign customers with satisfactory factory products. Let Mankun be your trusted partner.

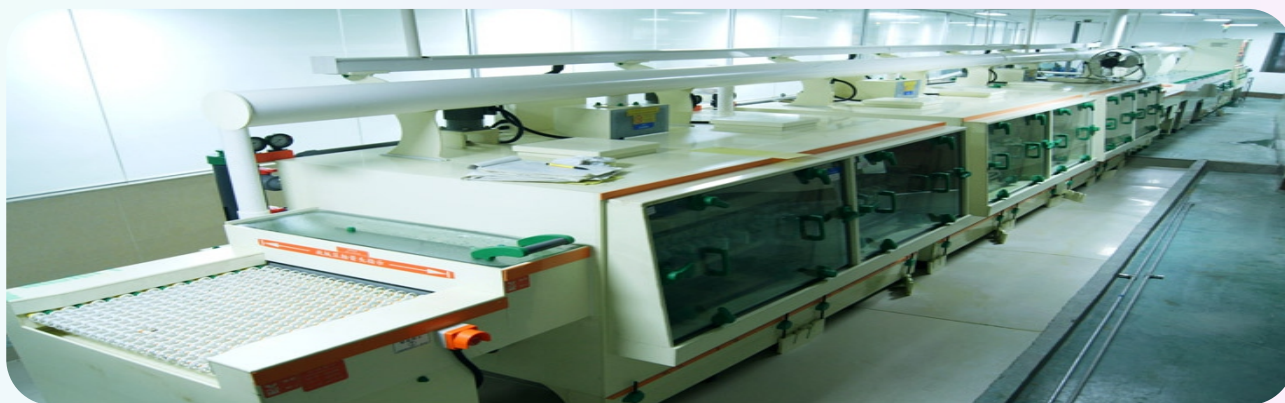

● Enterprise brief introduction 企業簡介	1-4
● Enterprise culture 企業精神	5-6
● Enterprise structure 企業架構	7
● Enterprise environment 企業環境	8
● Product introduction 產品介紹	9-12
● Product display 產品展示	13-14
● Process capability 加工能力	15
● Corporate honor 企業榮譽	16

## 企業簡介

# ABUOT MANKUN

2018 Outstanding Patent Attorney in Guangzhou



**Guangzhou Mankun Electronic Co.,Ltd** is a high-tech joint management enterprise. It specialized in research&development and also specialized in production for rigid printed circuit board and the flexible printed circuit board.

The company was established on August 28th, 2005. It had been devoted technology innovation to provide the most satisfied and quality service. It has modernized standard workshop reaches nearly 3,000 square meters for production and more than 300 employees.



**广州满坤电子有限公司**是一家专业从事研发和生产硬质印刷线路板及挠性印刷线路板的高科技合资联营企业。

公司于2005年8月28日成立至今，一直致力于为电子科技的创新与持续发展，提供最优质最满意的服务。现已拥有3000平方生产场地，员工300多人。公司注重人员培训以及引进本行业的精湛技术，拥有一支高素质、快速高效的生产、研发、管理的职工队伍。

Mankun has the supporting of the high quality, low cost, and get the Electronic Information technology from domestic and abroad. The company strictly implements ISO9001 quality control system to instructing for each management. The factory technique strength is strong, advanced production level&management, After years of efforts and repeated the mix of resources. Mankun Electronic is shaping a new face for its brand.





一站式LED線路板

## ONE-STOP LED PCB DEVELOP AND

As a PCB supplier, Mankun not only provides one-stop services such as PCB design, PCB manufacturing, PCB assembly and so on, but also integrates and innovates with different resources, as a professional and technical team with 13 years of PCB manufacturing experience. The team has laid a solid technical strength for the development and design of the whole LED lighting scheme, and has played a great advantage in the rapid delivery time and price competitiveness without affecting the quality.

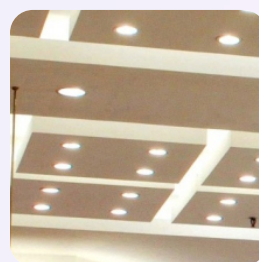

拥有一支具有13年PCB制造经验的专业技术队伍，不断提高PCB技术水平和生产能力。作为PCB供应商，滿坤不仅提供PCB设计、PCB生产、PCB组装等一站式服务，經過不同的資源整合與創新，團隊為開發設計整個LED照明方案奠定了雄厚的技術實力，而且在不影响质量的前提下，在快速交货时间和价格竞争力方面发挥了巨大的优势。

Development and Design of LED Lighting Scheme  
開發設計LED照明方案

Assembly test production LED PCB  
組裝測試生產LED PCB

SKD parts distribution  
零部件配套配送

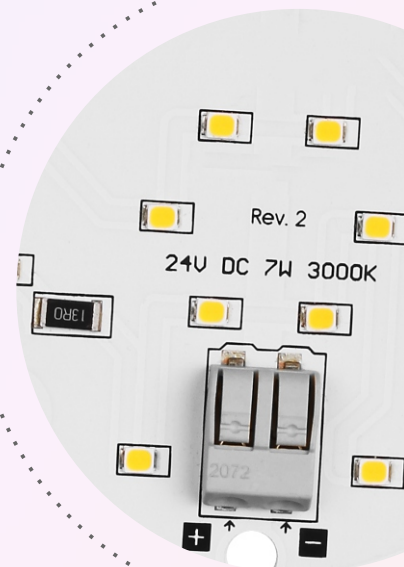

BUSINESS BROCHURE

# 企業精神

## ENTERPRISE SPIRIT

2018 Outstanding Patent Attorney in Guangzhou

Quality is the cornerstone of establishing a brand in an enterprise. Brand represents product quality and service Quality, reflect the company's reputation, reputation and customer loyalty to the enterprise brand. In the process of realizing the strategic goal of the enterprise, the company has cast fine products inside the company, shaping the image outside the company, and casting the image. International brand.

質量是企業樹立品牌的基石。品牌代表著產品質量和服務質量，體現企業知名度、信譽度和客戶對企業品牌的忠誠度。在實現企業戰略目標進程中，公司內鑄精品，外塑形象，鑄就國際品牌。



Open up  
開拓

Enterprising  
進取

Innovate  
創新

Rigorous  
嚴謹

Integrity  
誠信

Highly active • Craftsman • Profession  
高效 工匠 專業





Corporate Culture: Innovation quality, High efficiency, Create excellence service, Innovation future.

企業文化

創新品質、創造效率、創優服務、創新未來

Goal: to create a world-class brand of products and services.

企業目標

創建一流的產品及服務品牌

Purpose: create value for customers, provide opportunities for employees and create benefits for the company.

企業宗旨

為顧客創造價值、為員工提供機會、為公司創造效益

Strategy: to produce the most needed products to meet the diversified needs of customers.

企業使命

創新科技，為電子行業提供優質產品及服務

Service concept:

Create quality Service and pursue customer satisfaction.

服務理念

打造精品服務，追求客戶滿意

## 工廠架構

## FACTORY ARCHITECTURE

2018 Outstanding Patent Attorney in Guangzhou

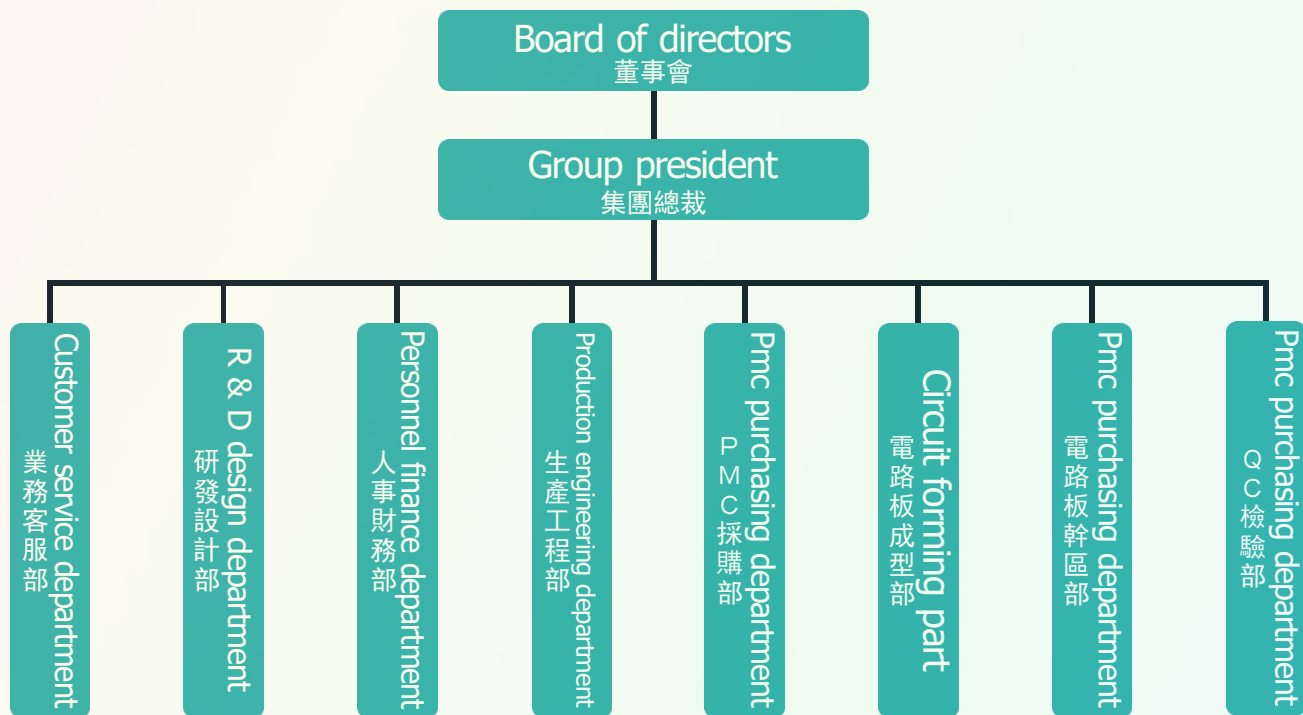

13 years of professional hardware development, Constantly innovating and making First-class PCB products.

13年的專業硬件開發歷程，不斷創新，創優服務於國內外客戶，製造一流線路板產品。



With customer IDEA and customer experience as the starting point, we can provide professional customizing service for customers and enjoy high standard and efficiency service of hardware..

以客戶方案及客戶體驗為出發點，提供專屬為客戶的專業定制服務，享有硬件高標準效率服務。

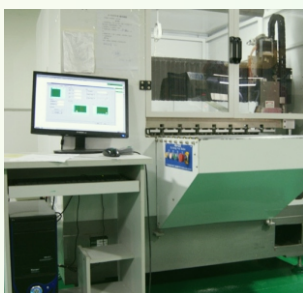

More than 20 imported fully automatic production equipment from Japan, Taiwan and other places. Guarantee the good product rate and control the time Production benefit.

20多種先進設備，來自日本、台灣等進口全自動生產設備，保證產品良品率，掌控時間生產效益。

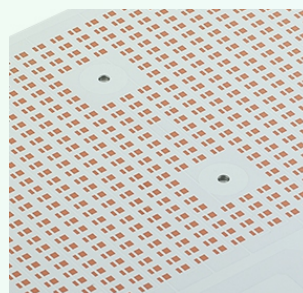

The high strength circuit with fine material selection, high heat dissipation and high density has small volume, good heat dissipation effect and good insulation and mechanical properties..

選材精細，高散熱、高密度的高強電路具備體積小，散熱效果好，良好的絕緣性能和機械性能。



# 工廠管理

# FACTORY MANAGEMENT

2018 Outstanding Patent Attorney in Guangzhou

- ▶ Business concept Innovative concept thinking ahead, Scientific management lead, Credit management lead. 經營理念：創新思維領先、科學管理領先、誠信經營領先。





## 產品介紹

## PRODUCT INTRODUCTION

2018 Outstanding Patent Attorney in Guangzhou

## ▶▶ Direct thermal path PCB 熱電分離銅基板

Copper PCB have good and strong heat dissipation capability, mainly used in LED Car light and high power COB areas which need high heat dissipation.

銅基板具有強大的散熱性能，主要應用於LED車燈，大功率封裝等高散熱領域。

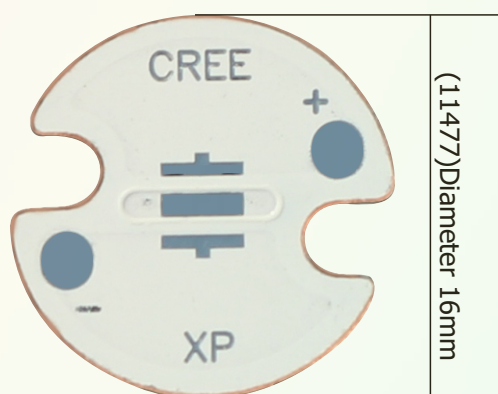

(13116) 20PCS/PNL

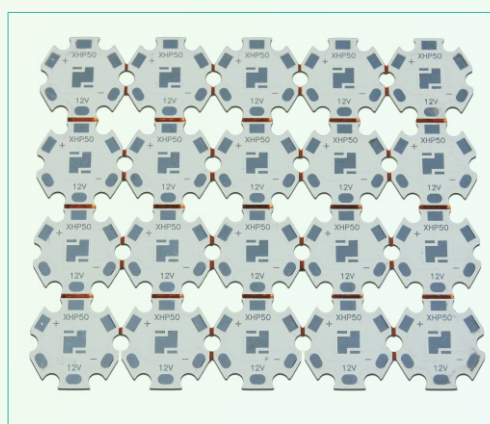

CREE full series heat and power separation board specification table, long-term stock.

CREE全系列熱電分離公板規格表，長期備有庫存

規格尺寸 Specification Size(mm)	產品型號 Product Model	厚度/材質		LED 數量/Qty (pcs)	LED品牌/型號 Led brand / model	銅厚 Copper Thickness (oz)	拼板數量 Makeup (pcs/PNL)	表面處理 surface preparation 製作工藝 Manufacturing process
		Thickness (mm)	Material					
直徑 Diameter 16mm	11477	1.6	Copper Aluminum	1	CREE-XP	1	20	無鉛製作工藝 表面噴白油 焊盤噴錫  Moulding, lead-free tin spray, white oil
	13692	1.0		1	CREE-XML	1		
	13693	1.0		1	CREE-XP	1		
直徑 Diameter 20mm	11371	1.6	Copper Aluminum	1	CREE-XP	1	20	
	11372	1.6		1	CREE-XML	1		
	13116	1.6		1	CREE-XP	1		
	13117	1.6		1	CREE-XML	1		
	11493	1.6		1	CREE-XP	1		
	8990	1.0		1	5050	1		
	8991	1.0		1	5050	1		
方形 Square	35 X 35	1.6	Copper Aluminum	9	5050	1	21	
	50 X 50	1.6		16		1		
	50 X 50	1.6		16		1		
	60 X 60	1.6		32	1			
	60 X 60	1.6		24	1			
	60 X 60	1.6		20	1			
	40 X 40	1.6		36	1			
	40 X 40	1.6		30	2525	1		
	40 X 40	1.6		20		1		
	40 X 40	1.6		16		1		
	40 X 40	1.6		12	3535	1		
	40 X 40	1.6		36		1		
	40 X 40	1.6		30		1		
	40 X 40	1.6		20		1		
	40 X 40	1.6		16		1		
40 X 40	1.6	12	1					

# SINK PATH PCB DIAGRAM 熱電分離示意圖

► Heat dissipation process of thermoelectric sink path PCB 熱電分離銅基板的散熱過程

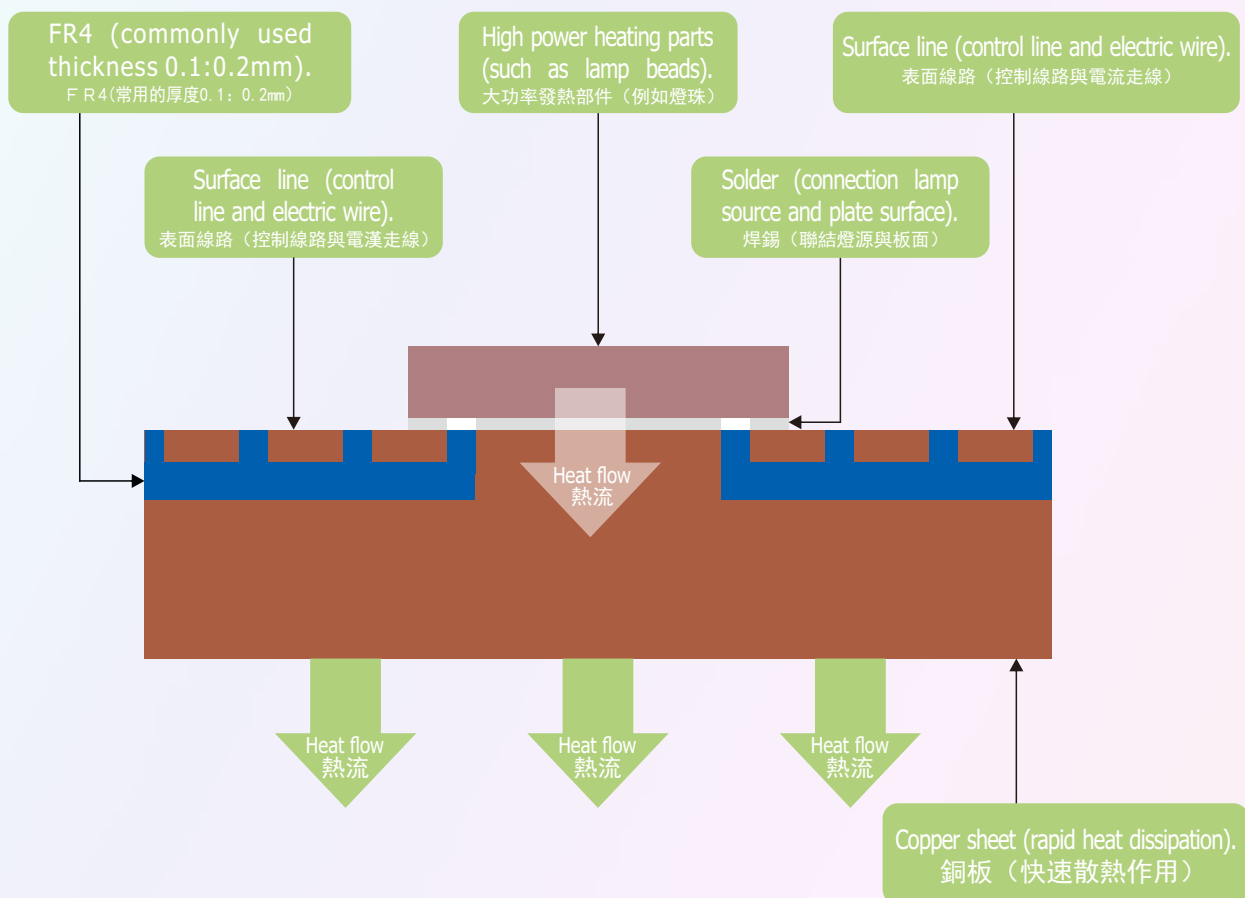

# 產品介紹

# PRODUCT INTRODUCTION

2018 Outstanding Patent Attorney in Guangzhou

## ▶ Single sided aluminum PCB 單面鋁基板

Al PCB mainly used in LED lighting industry, including Commercial Lighting, Indoor & Outdoor Lighting, Medical Lighting, etc.

鋁基板，主要應用於LED照明領域，涵蓋商業照明，室內外照明，醫療照明等.....



(A259169) 1 PCS/PNL

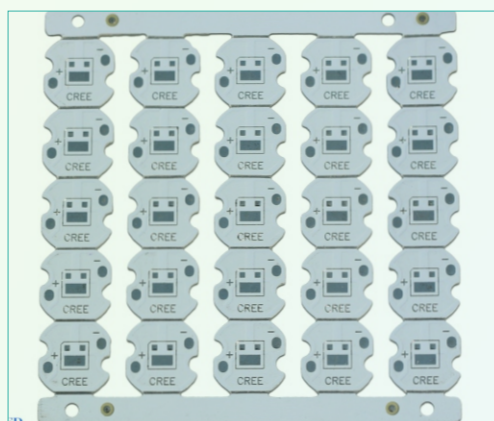

(A128644) 25 PCS/PNL

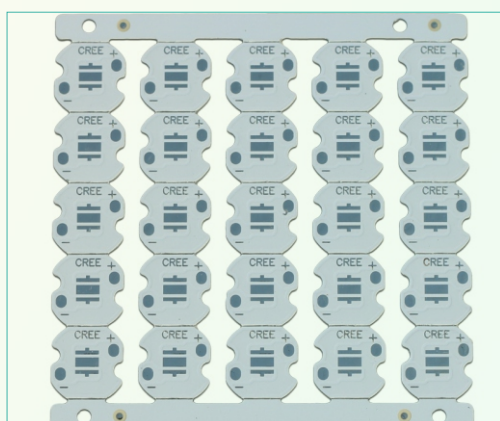

(A168642) 25 PCS/PNL



(A168642 MINI) 30 PCS/PNL



# CREE full range of public board specifications for a long time.

CREE全系列金屬公板規格表，長期備有庫存

規格尺寸 Specification Size(mm)	產品型號 Product Model	厚度/材質		LED 數量/Qty (pcs)	LED品牌/型號 Led brand / model	銅厚 Copper Thickness (oz)	拼板數量 Makeup (pcs/PNL)	表面處理 surface preparation 製作工藝 Manufacturing process
		Thickness (mm)	Material					
直徑8mm Diameter 8mm	A85675	1.0	Aluminum	1	CREE XP	1	42	無鉛製作工藝 表面噴白油 焊盤噴錫  Moulding, lead-free tin spray, white oil
	A82305	1.0		1	3030	1		
	A87575	1.0		1	CREE XBD	1		
	A82598	1.0		1	REBEL	1		
直徑Diameter 9.8mm	A988668	1.2	Aluminum	1	CREE XP	1	24	
直徑Diameter 10mm	A106794	1.0		1		1	20	
直徑Diameter 12.8mm	A1286535	1.0		1		1	1	
直徑Diameter 13.7mm	A13710196	1.6		1		1	20	
直徑12mm Diameter 12mm	A127498	1.0	Aluminum	1	CREE XP	1	25	
	A127576	1.0		1	CREE XBD	1		
	A127513	1.0		1	CREE XML	1		
	A128644	1.0		1	REBEL	1		
	A129646	1.2		1	CREE XP	1		
	A127497	1.0		1	CREE XRE	1		
	A128005	1.0		1	3030	1		
	A127909	1.0		1	5630	1		
直徑14mm Diameter 14mm	A148264	1.0	Aluminum	1	CREE XP	1	40	
	A145558	1.0		1	CREE XML	1	40	
	A148667	1.0		1	CREE XP	1	40	
	A149997	1.6		1	CREE XBD	1	40	
	A147577	1.0		1	3030	1	1	
	A148643	1.0		1	REBEL	1	40	
直徑16mm Diameter 16mm	A167237	1.0	Aluminum	1	CREE XP	1	30	
	A167578	1.0		1	CREE XBD	1		
	A167397	1.0		1	CREE XML	1		
	A168521	1.0		1	3030	1		
	A168088	1.0		1	5630	1		
	A1610284	1.0		2	CREE XP	1		
	A166949	1.0		1	CREE XRE	1		
	A168817	1.0		1	CREE XML	1		
	A168983	1.0		1	3030	1		
A168642	1.0	1	REBEL	1				
直徑18mm Diameter 18mm	A188504	1.0	Aluminum	1	CREE XP	1	20	
	A186590	1.0		1	CREE XML	1		
	A1810192	2.0		1	CREE XML	1		
	A1810040	1.6		1	CREE XP	1		
	A186641	1.6		1	CREE XML	1		
	A1810039	2.0		1	UV365-D	1		
直徑20mm Diameter 20mm	A207391	1.6	Aluminum	1	CREE XP	1	20	
	A205130	1.6		1	CREE XP	1		
	A2010166	1.6		2	CREE XP	1		
	A202055	1.6		1	CREE XBD	1		
	A206932	1.6		3	CREE XBD	1		
	A206692	1.6		4	CREE XML	1		
	A207714	1.6		1	CREE XP	1		
	A206538	1.6		1	CREE XBD	1		1
	A208944	1.6		1	CREE XML	1		1
	A207390	1.6		1	CREE XML	1		20
	A209279	1.6		1	CREE XML-RGBW	1		20
	A207392	1.6		1	CREE XRE	1		1
	A206753	1.6		1	OSRAM	1		20
	A206588	1.6		1	EDISON	1		20
	A208804	1.6		1	CREE MTG	1		1
	A2010074	1.6		1	2835	1		20
	A208658	1.6		1	OSRAM 3030	1		20
	A206752	1.6		1	CREE MX-6	1		1
A207487	1.6	1	MCE-RGBW	1	20			
A207265	1.6	1	MCE-RGBW	1	20			
直徑Diameter 25mm	A259170	2.0	Aluminum	1	CREE XP	1	1	
直徑Diameter 25mm	A259169	2.0		1	CREE XML	1	1	
直徑Diameter 32mm	A328647	2.0		1	EDISON	1	1	
直徑Diameter 32mm	A323846	2.0		1	CREE XML	1	1	

# 产品展示

# PRODUCT INTRODUCTION

2018 Outstanding Patent Attorney in Guangzhou

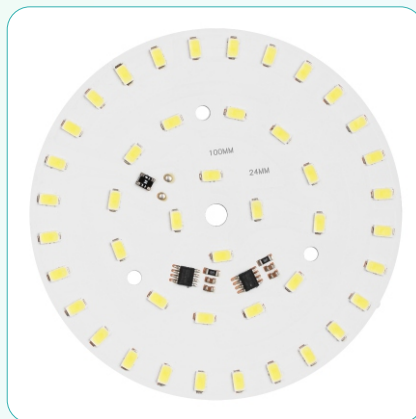
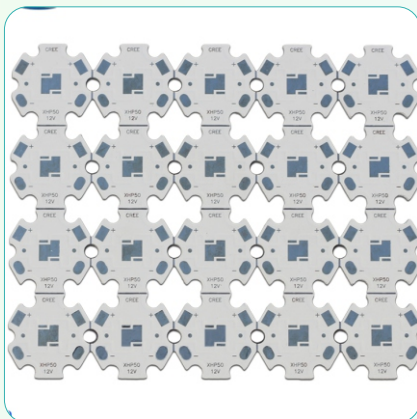
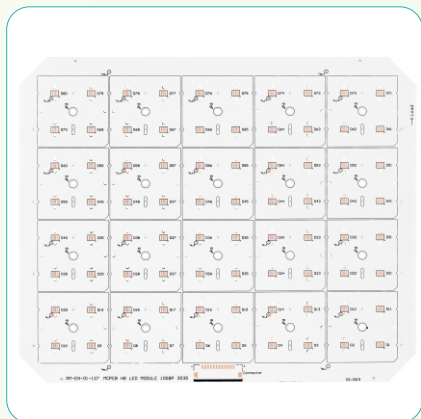
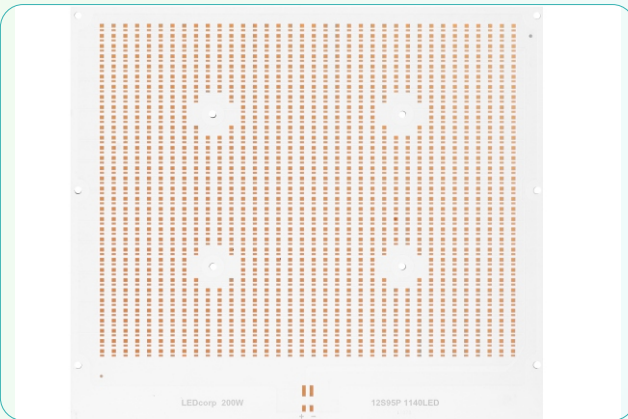
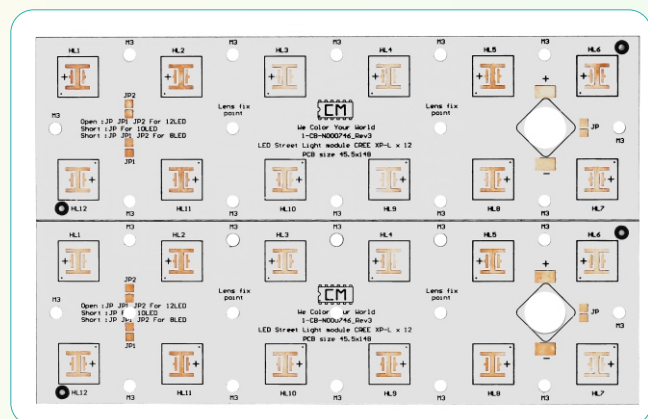
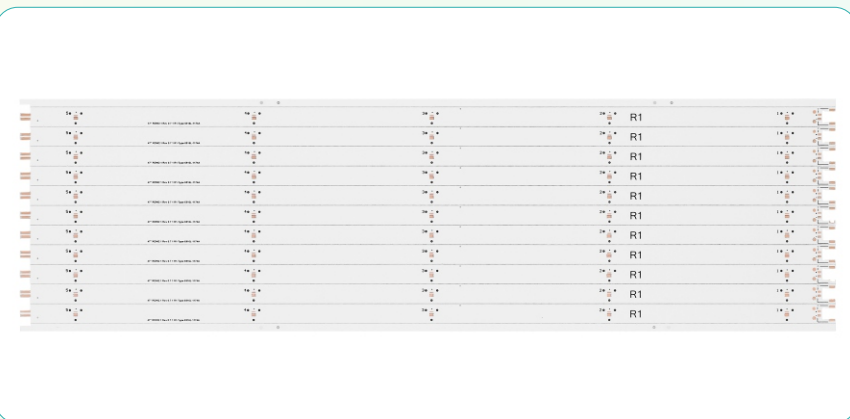
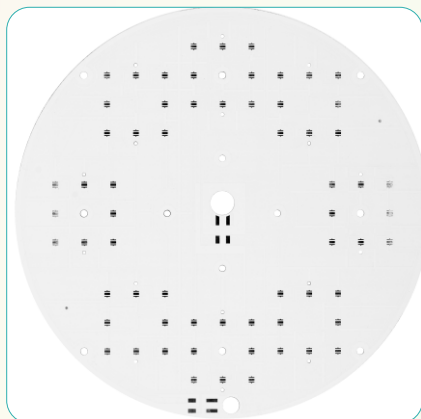
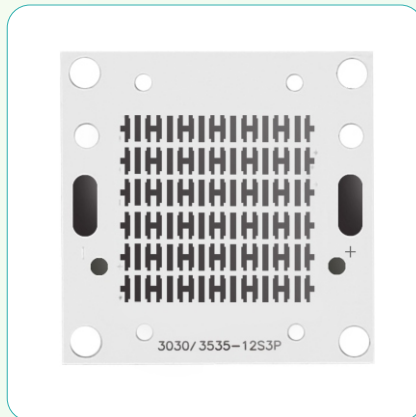
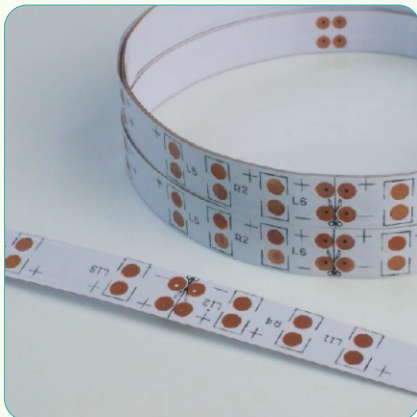
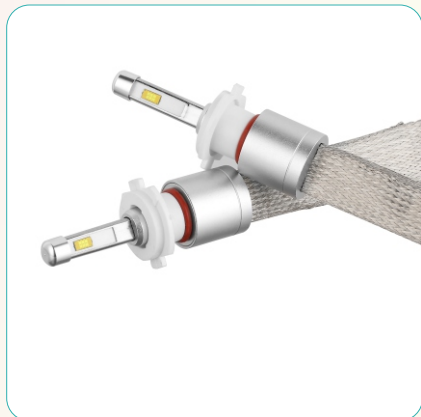

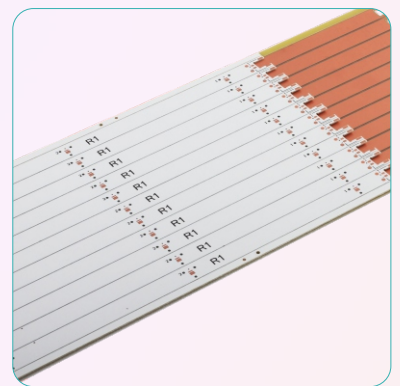
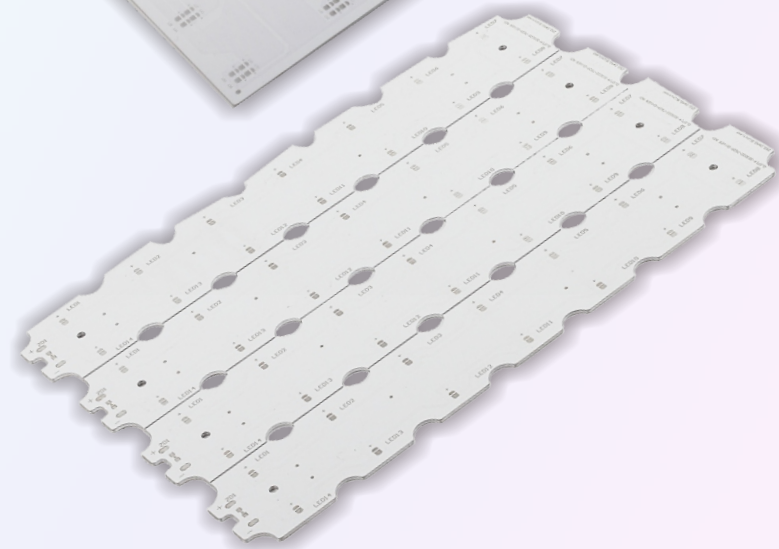
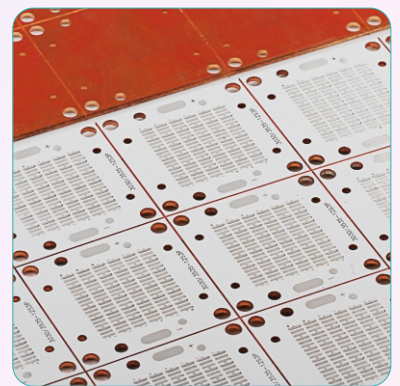
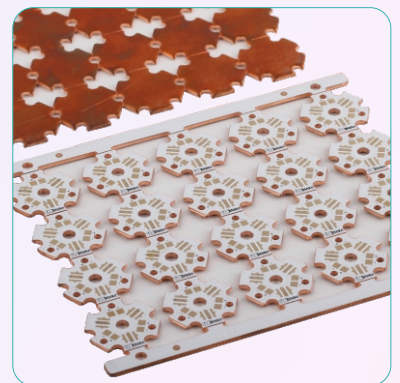
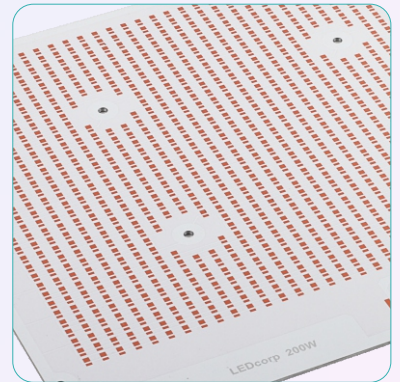

## 加工能力

## PRODUCTION CAPABILITY

2018 Outstanding Patent Attorney in Guangzhou

PROCESSING FLOW CHART

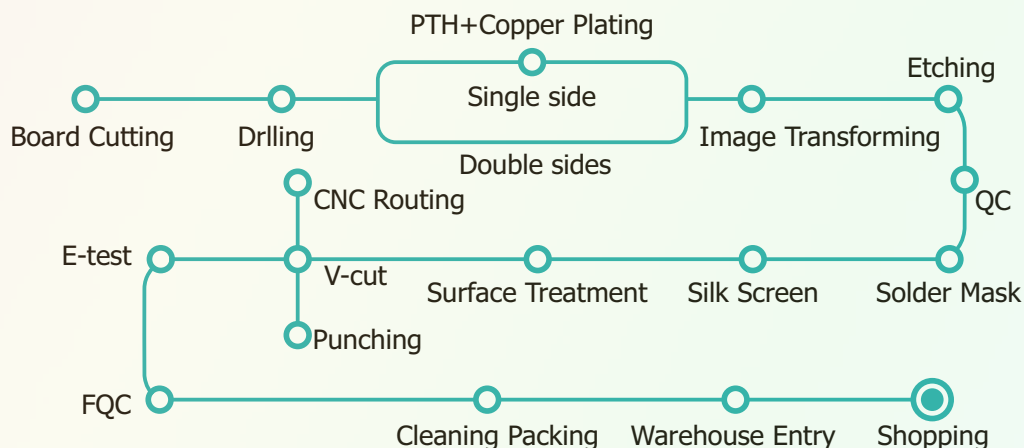

ITEM	SPECIFICATION
Surface	LF HASL,immersion gold,immersion silver,OSP
Layer	Single side,double sided Multilayer and special structure
Maximum PCB size	240mm*1490mm
PCB thickness	0.4-3.0mm
Copper Foil thickness	H 1 2 3 4oz
Insulation layer thickness	50 75 100 125 150 175 200um
Metal Base thickness	Al(1100 3003 5052 6061)
Metal Base thickness	0.5 0.8 1.0 1.2 2.0 3.2 5.0(mm)
Shaping	Die punching/CNC Route/CNC V-Cut
Test	100% open&short test
Hole tolerance	+ -0.05mm
Min.Hole Diameter	Single side 0.5/Double sided PTH0.3MM
Solder mask	green/white/black/red/yellow
Min.letter height	0.8mm
Min.line space	0.15
Min.letter width	0.15
Silk screen color	blue/white/black/red/yellow
Special hole	Spot facing/cup hole/buried via hole/buried tank



# CORPORATE HONOR

2018 Outstanding Patent Attorney in Guangzhou

企業榮譽



In the company of "quality first excellence" quality policy,actively promote the ISO9001 quality system,the products are widely exported to America,Europe,Russia,Singapore,South Korea and other countries and regions. The products are widely used in the field of computer,communications,aerospace,automotive,power supply,LED lighting and general consumer electronics products such as products certified by UL to comply with EU ROHS requirements, performance of the IPC,MIL standards .



Quality concept: quality first, continuous improvement, pursuit of excellence.  
 質量理念：質量第一、持續改進、追求卓越。



Guang Zhou Mankun Electronic Co.,Ltd  
廣州滿坤電子有限公司



[HTTP://WWW.MANKUN.NET](http://www.mankun.net)  
工廠網站



[HTTPS://WWW.MANKUN.EN.ALIBABA.COM](https://www.mankun.en.alibaba.com)  
國際商鋪



[HTTPS://MANKUN.1688.COM](https://mankun.1688.com)  
國內網店

## CONTACT US

Head Office / 台灣總公司

MANKUN ELECTRONIC CO.,LTD

(11051) 11F.,No.398,Sec.1,Keelung Rd.,Xinyi District,Taipei City,Taiwan

(11051) 台北市信義區基隆路一段398號11樓

Tel:886-2-8601-2515

Fax:886-2-8192-6487

[Http://www.mankun.com.tw](http://www.mankun.com.tw) E-Mail:seles@mankun.com.tw

Guangzhou Factory / 廣州工廠

GUANGZHOU MANKUN ELECTRONIC CO.,LTD

No.40 Shinan Street, Dawen Village,Dongchong Town, Nansha Dist., Guangzhou, Guangdong, China

中國 廣東省 廣州市南沙區東涌鎮大穩村市南路東涌段40號

Tel: 86-20-3483-2899

Fax: 86-20-8072-0030

[Http://www.mankun.net](http://www.mankun.net)

E-Mail:bellum@mankun.com.tw



滿坤電子



BUSINESS BROCHURE

# 產品畫冊



Guang Zhou Mankun Electronic Co.,Ltd

廣州滿坤電子有限公司